

X14



Centro Nautico
ADRIATICO

VIA CAGNONA, 913
47030 SAN MAURO PASCOLI A MARE (FC)
TEL. 0541-938040 FAX 0541-938084









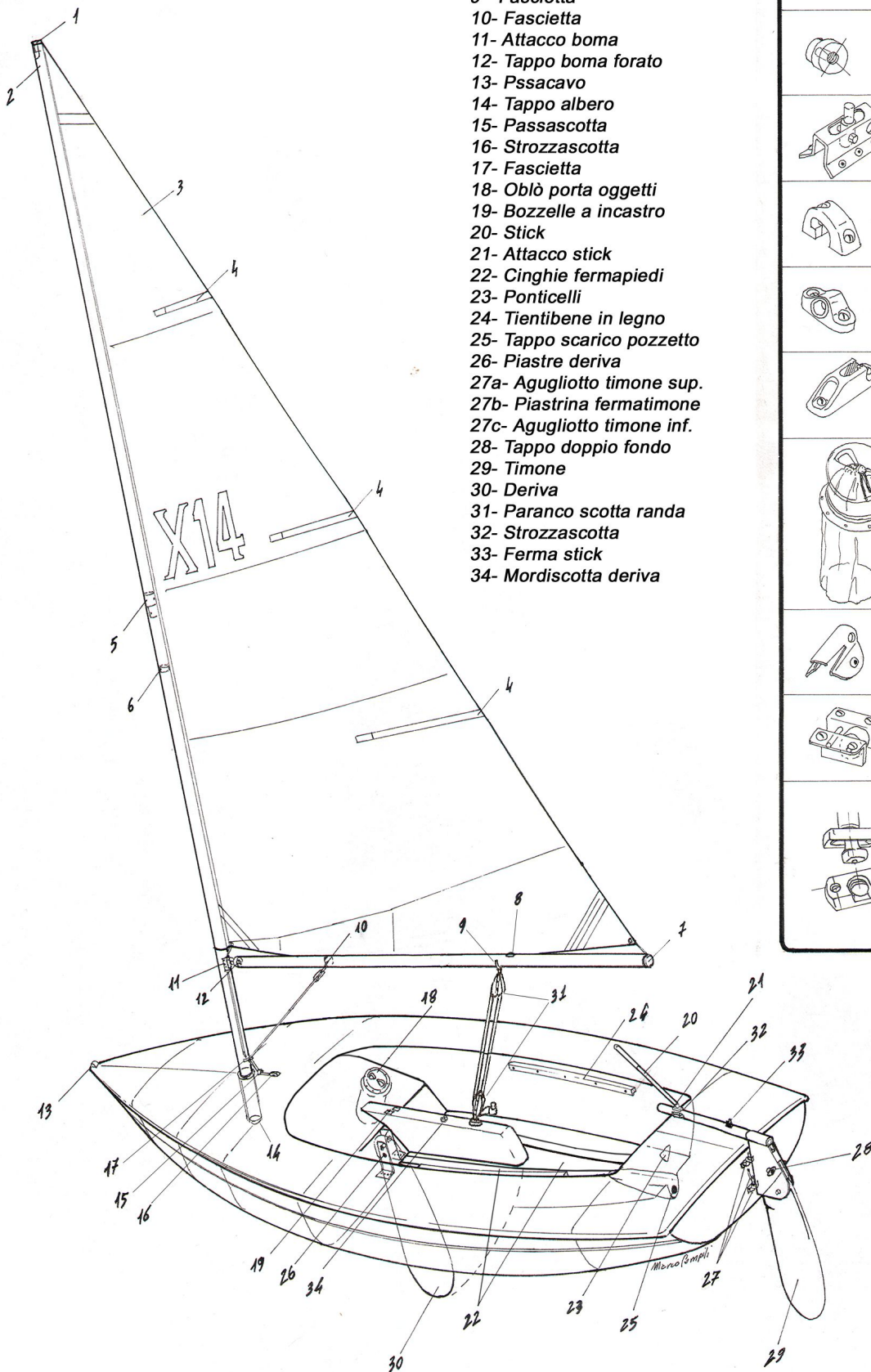













X14

COMPONENTISTICA

- 1- Tappo testa albero
- 2- Testa albero
- 3- Randa
- 4- Stecche
- 5- Boccola incastro
- 6- Tappo albero
- 7- Tappo boma
- 8- Strozzascotta
- 9- Fascietta
- 10- Fascietta
- 11- Attacco boma
- 12- Tappo boma forato
- 13- Pssacavo
- 14- Tappo albero
- 15- Passascotta
- 16- Strozzascotta
- 17- Fascietta
- 18- Oblò porta oggetti
- 19- Bozzelle a incastro
- 20- Stick
- 21- Attacco stick
- 22- Cinghie fermapiedi
- 23- Ponticelli
- 24- Tientibene in legno
- 25- Tappo scarico pozzetto
- 26- Piastre deriva
- 27a- Agugliotto timone sup.
- 27b- Piastrina fermatimone
- 27c- Agugliotto timone inf.
- 28- Tappo doppio fondo
- 29- Timone
- 30- Deriva
- 31- Paranco scotta randa
- 32- Strozzascotta
- 33- Ferma stick
- 34- Mordiscotta deriva

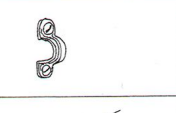
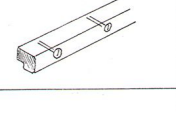
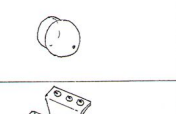
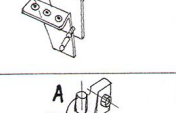
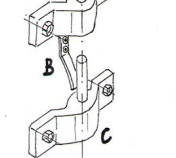
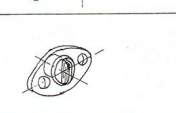
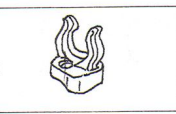
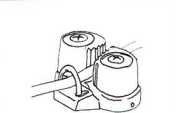
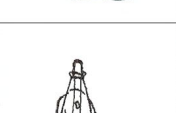
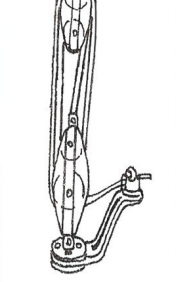

	1
	6
	7
	14
	5
	9
	10
	17
	12
	11
	13
	15
	16
	32
	18
	8
	19
	20
	21

	22
	23
	24
	25
	26
	27
	28
	33
	34
	31
	29